

# F9 Flooding Lights (40/60/80/100/120/150W)



## Certification

IP66

## Basic Product Specification

|  |  |
|--|--|
| <p><b>Application</b><br/>Small volume with multiple beam angle.<br/>Easy to install in complicate environment,<br/>like factory, warehouse, harbor.</p> <p>Working Tempature: -20°C to 40°C</p> | <p><b>Mechanical</b><br/><b>Housing:</b> Aluminum Alloy<br/><b>Lens:</b> Glass<br/><b>Setting Type:</b><br/>Suspended Type</p> <p><b>Weight:</b> &lt;4kg</p> |
| <p><b>Optical</b><br/><b>Lumen:</b> 3,400-20,250Lm<br/><b>CCT:</b> 3000K, 5700K<br/><b>CRI:</b> Ra ≥ 80@3000K, Ra ≥ 70@5700K<br/><b>Beam Angle:</b><br/>X-Y-15°, X-Y-56°, X-Y-95°, X-Y-140°</p>  | <p><b>Electrical</b><br/><b>Voltage:</b> 100-277VAC<br/><b>Watt:</b> 40/60/80/100/120/150W<br/><b>Power Factor:</b> &gt;0.9</p>                              |

## Product Code Rule **F9 Flooding Lights 40W 5700K**

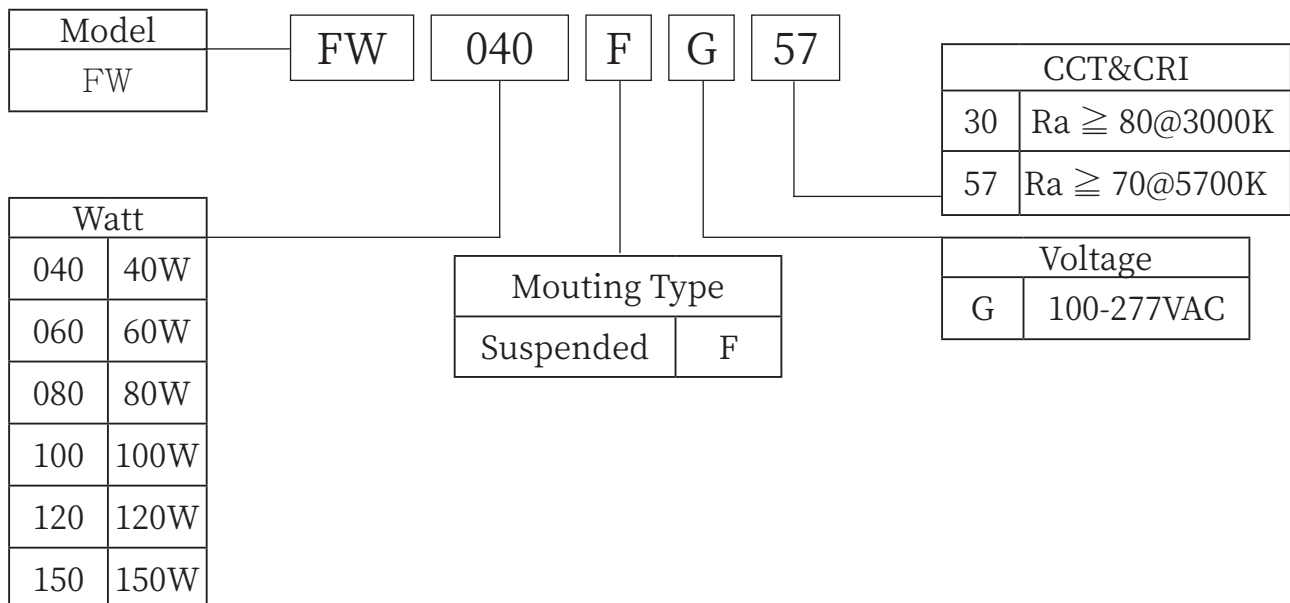

# Dimensions

## Suspended Type

40/60/80W

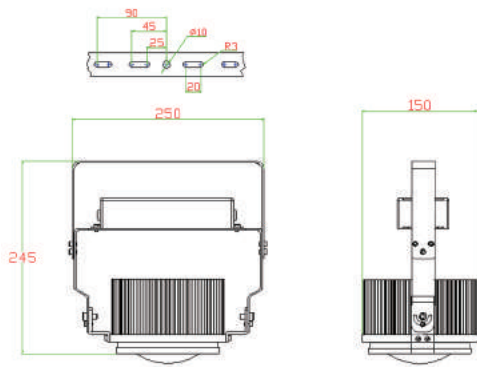

120/150W

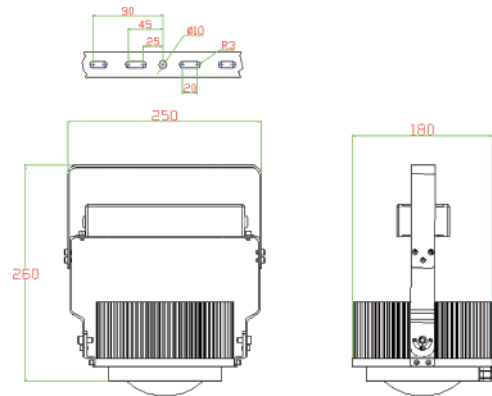

# Optical Diagram

## Lux at a distance

### 40W(15° /56° /95° /140°)

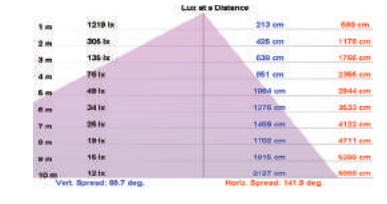
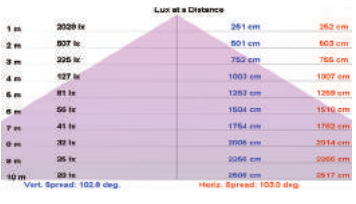

### 60W(15° /56° /95° /140°)

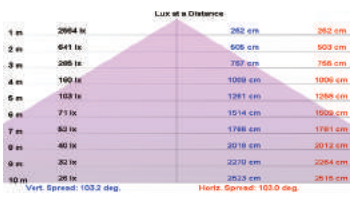
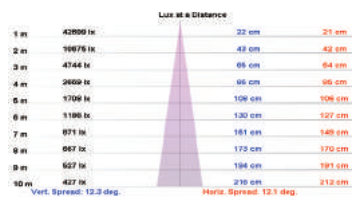

### 80W(15° /56° /95° /140°)

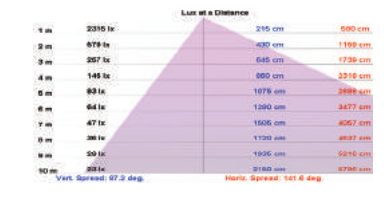
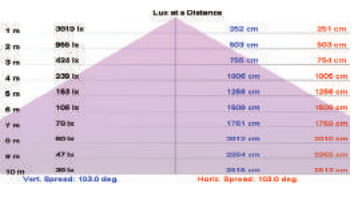
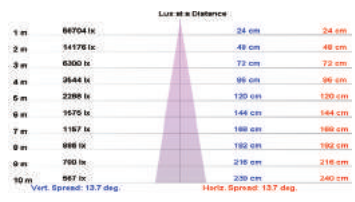

### 100W(15° /56° /95° /140°)

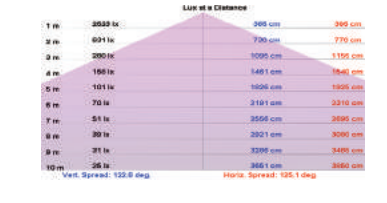
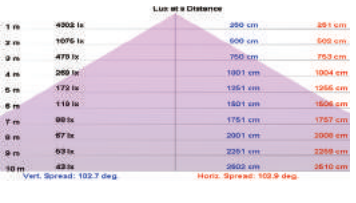
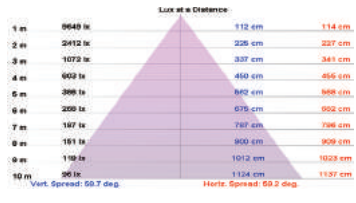
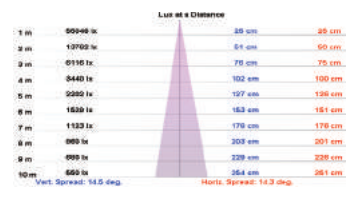

### 120W(15° /56° /95° /140°)

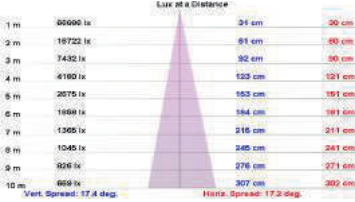

## Distribution

### 40W(15° /56° /95° /140°)

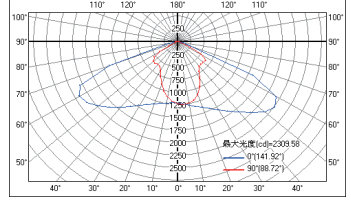
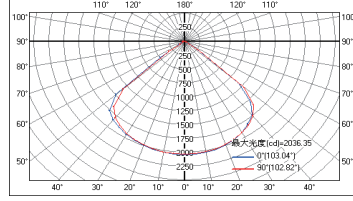
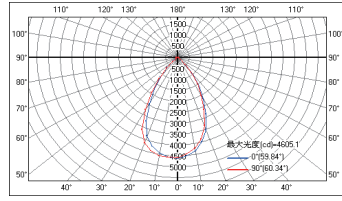
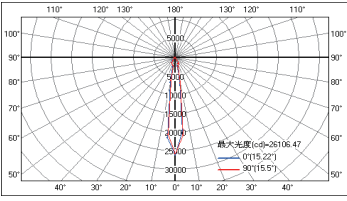

### 60W(15° /56° /95° /140°)

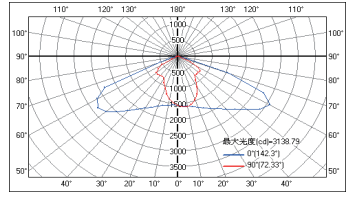
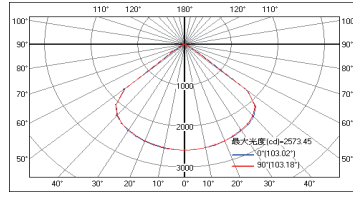
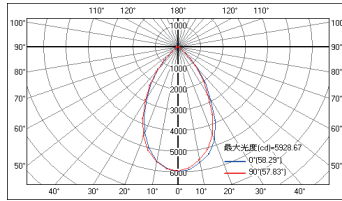
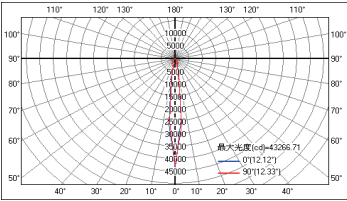

### 80W(15° /56° /95° /140°)

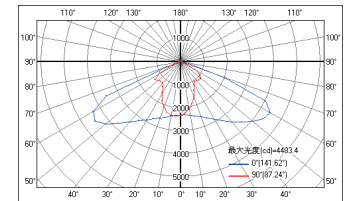
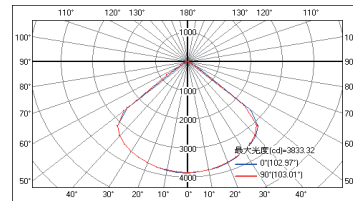
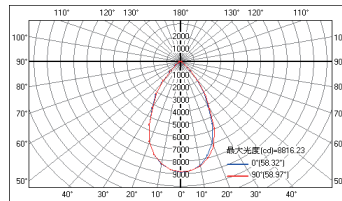
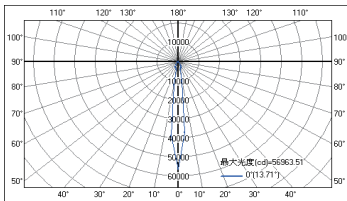

### 100W(15° /56° /95° /140°)

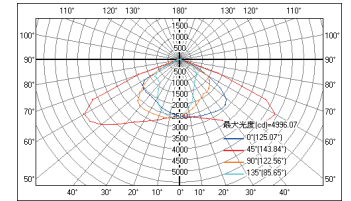
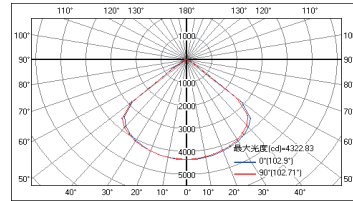
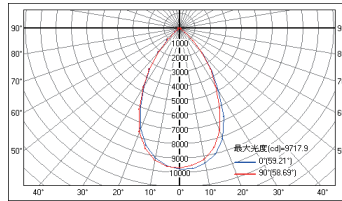
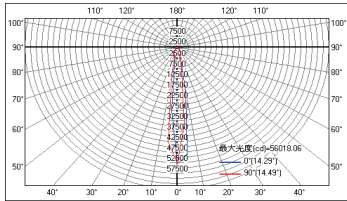

### 120W(15° /56° /95° /140°)

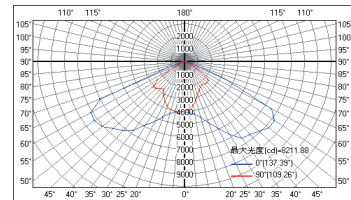
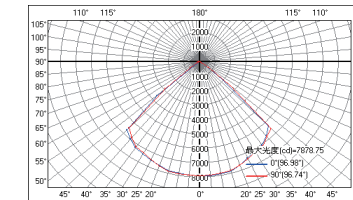
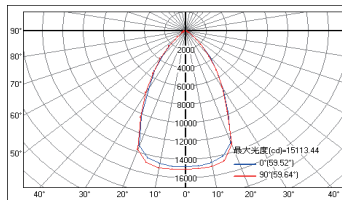
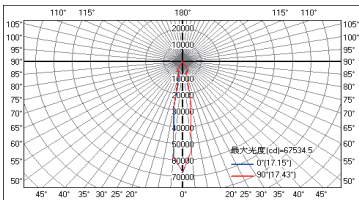

### 150W(15° /56° /95° /140°)

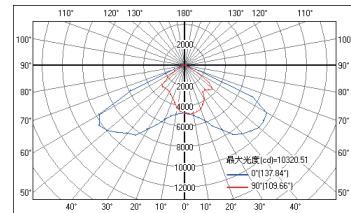
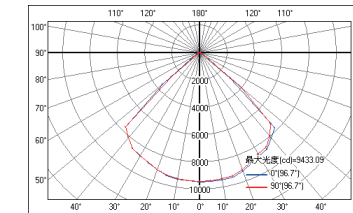
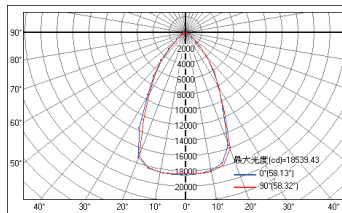
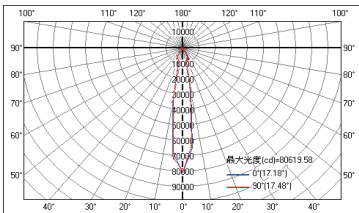



# Product Number & Technical Detail



| Watt  | Voltage    | Lumen      | Angle     |
|-------|------------|------------|-----------|
| 40W   | 100-277VAC | 3,400lm    | see table |
| CCT   | CRI        | Efficiency | Weight    |
| 5700K | Ra ≥ 70    | 85lm/w     | 3kg       |

| Mounting      | Model Number  |
|---------------|---------------|
| Suspended 15° | HW040FG57-015 |



| Watt  | Voltage    | Lumen      | Angle     |
|-------|------------|------------|-----------|
| 60W   | 100-277VAC | 5,100lm    | see table |
| CCT   | CRI        | Efficiency | Weight    |
| 5700K | Ra ≥ 70    | 85lm/w     | 3kg       |

| Mounting      | Model Number  |
|---------------|---------------|
| Suspended 15° | HW060FG57-015 |



| Watt  | Voltage    | Lumen      | Angle     |
|-------|------------|------------|-----------|
| 80W   | 100-277VAC | 6,800lm    | see table |
| CCT   | CRI        | Efficiency | Weight    |
| 5700K | Ra ≥ 70    | 85lm/w     | 3kg       |

| Mounting      | Model Number  |
|---------------|---------------|
| Suspended 15° | HW080FG57-015 |



| Watt  | Voltage    | Lumen      | Angle     |
|-------|------------|------------|-----------|
| 100W  | 100-277VAC | 10,000lm   | see table |
| CCT   | CRI        | Efficiency | Weight    |
| 3000K | Ra ≥ 70    | 100lm/w    | 3kg       |

| Mounting      | Model Number  |
|---------------|---------------|
| Suspended 15° | HW100FG30-015 |



| Watt  | Voltage    | Lumen      | Angle     |
|-------|------------|------------|-----------|
| 40W   | 100-277VAC | 4,000lm    | see table |
| CCT   | CRI        | Efficiency | Weight    |
| 5700K | Ra ≥ 70    | 100lm/w    | 3kg       |

| Mounting       | Model Number  |
|----------------|---------------|
| Suspended 56°  | HW040FG57-056 |
| Suspended 95°  | HW040FG57-095 |
| Suspended 140° | HW040FG57-140 |



| Watt  | Voltage    | Lumen      | Angle     |
|-------|------------|------------|-----------|
| 60W   | 100-277VAC | 6,000lm    | see table |
| CCT   | CRI        | Efficiency | Weight    |
| 5700K | Ra ≥ 70    | 100lm/w    | 3kg       |

| Mounting       | Model Number  |
|----------------|---------------|
| Suspended 56°  | HW060FG57-056 |
| Suspended 95°  | HW060FG57-095 |
| Suspended 140° | HW060FG57-140 |



| Watt  | Voltage    | Lumen      | Angle     |
|-------|------------|------------|-----------|
| 80W   | 100-277VAC | 8,000lm    | see table |
| CCT   | CRI        | Efficiency | Weight    |
| 5700K | Ra ≥ 70    | 100lm/w    | 3kg       |

| Mounting       | Model Number  |
|----------------|---------------|
| Suspended 56°  | HW080FG57-056 |
| Suspended 95°  | HW080FG57-095 |
| Suspended 140° | HW080FG57-140 |



| Watt  | Voltage    | Lumen      | Angle     |
|-------|------------|------------|-----------|
| 100W  | 100-277VAC | 13,500lm   | see table |
| CCT   | CRI        | Efficiency | Weight    |
| 3000K | Ra ≥ 70    | 135lm/w    | 3kg       |

| Mounting       | Model Number  |
|----------------|---------------|
| Suspended 56°  | HW100FG30-056 |
| Suspended 95°  | HW100FG30-095 |
| Suspended 140° | HW100FG30-140 |

# Product Number & Technical Detail



| Watt  | Voltage    | Lumen      | Angle     |
|-------|------------|------------|-----------|
| 100W  | 100-277VAC | 10,000lm   | see table |
| CCT   | CRI        | Efficiency | Weight    |
| 5700K | Ra ≥ 70    | 100lm/w    | 3kg       |

| Mounting      | Model Number  |
|---------------|---------------|
| Suspended 15° | HW100FG57-015 |



| Watt  | Voltage    | Lumen      | Angle     |
|-------|------------|------------|-----------|
| 120W  | 100-277VAC | 12,000lm   | see table |
| CCT   | CRI        | Efficiency | Weight    |
| 5700K | Ra ≥ 70    | 100lm/w    | 3kg       |

| Mounting      | Model Number  |
|---------------|---------------|
| Suspended 15° | HW120FG57-015 |



| Watt  | Voltage    | Lumen      | Angle     |
|-------|------------|------------|-----------|
| 150W  | 100-277VAC | 15,000lm   | see table |
| CCT   | CRI        | Efficiency | Weight    |
| 5700K | Ra ≥ 70    | 100lm/w    | 3kg       |

| Mounting      | Model Number  |
|---------------|---------------|
| Suspended 15° | HW150FG57-015 |



| Watt  | Voltage    | Lumen      | Angle     |
|-------|------------|------------|-----------|
| 100W  | 100-277VAC | 13,500lm   | see table |
| CCT   | CRI        | Efficiency | Weight    |
| 5700K | Ra ≥ 70    | 135 lm/w   | 3kg       |

| Mounting       | Model Number  |
|----------------|---------------|
| Suspended 56°  | HW100FG57-056 |
| Suspended 95°  | HW100FG57-095 |
| Suspended 140° | HW100FG57-140 |



| Watt  | Voltage    | Lumen      | Angle     |
|-------|------------|------------|-----------|
| 120W  | 100-277VAC | 16,200lm   | see table |
| CCT   | CRI        | Efficiency | Weight    |
| 5700K | Ra ≥ 70    | 135lm/w    | 3kg       |

| Mounting       | Model Number  |
|----------------|---------------|
| Suspended 56°  | HW120FG57-056 |
| Suspended 95°  | HW120FG57-095 |
| Suspended 140° | HW120FG57-140 |



| Watt  | Voltage    | Lumen      | Angle     |
|-------|------------|------------|-----------|
| 150W  | 100-277VAC | 20,250lm   | see table |
| CCT   | CRI        | Efficiency | Weight    |
| 5700K | Ra ≥ 70    | 135lm/w    | 3kg       |

| Mounting       | Model Number  |
|----------------|---------------|
| Suspended 56°  | HW150FG57-056 |
| Suspended 95°  | HW150FG57-095 |
| Suspended 140° | HW150FG57-140 |